

IB 16 32

Choisissez les casiers IB pour toutes vos bouteilles standards de 750 ml.
Choose IB racking to fit all of your standard 750ml bottles.

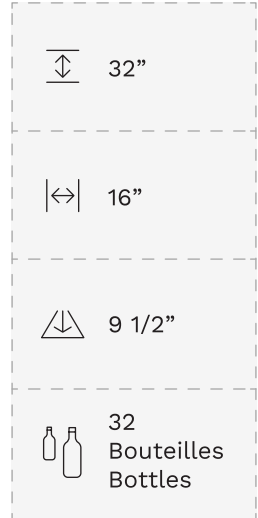
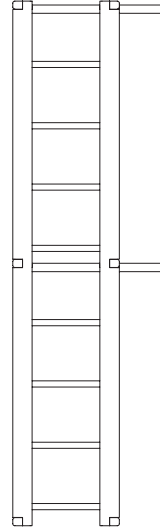
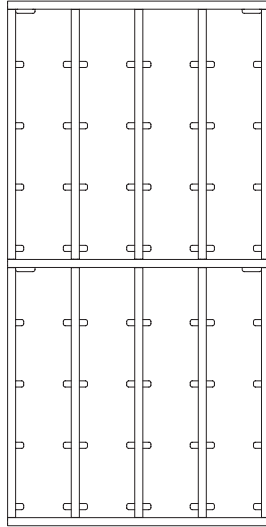
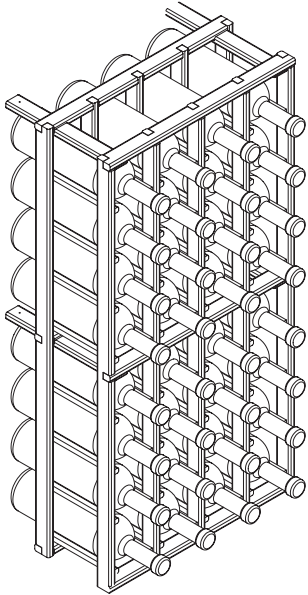

IB 16 48

Choisissez les casiers IB pour toutes vos bouteilles standards de 750 ml.
Choose IB racking to fit all of your standard 750ml bottles.

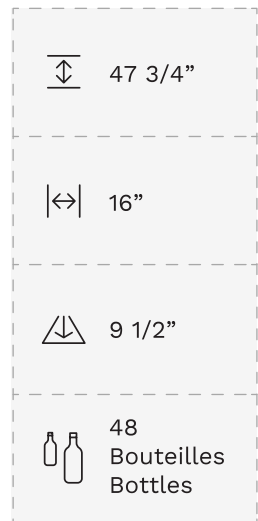
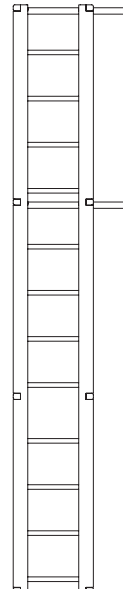
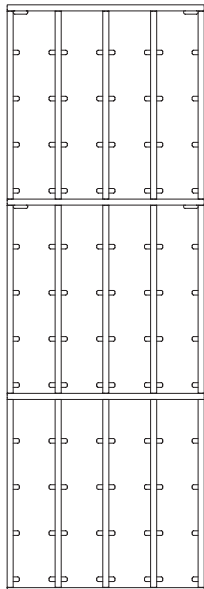
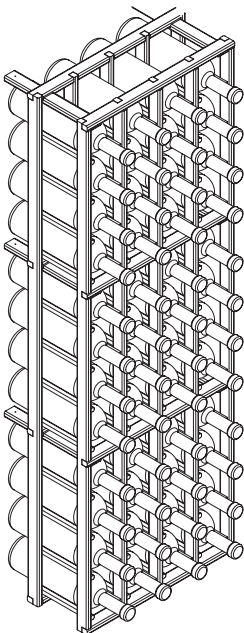

IB 32 32

Choisissez les casiers IB pour toutes vos bouteilles standards de 750 ml.
Choose IB racking to fit all of your standard 750ml bottles.

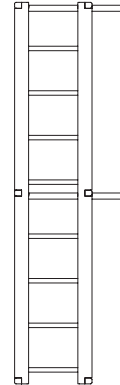
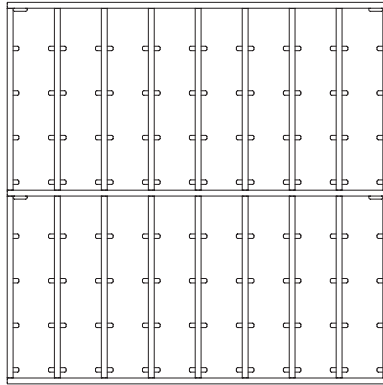
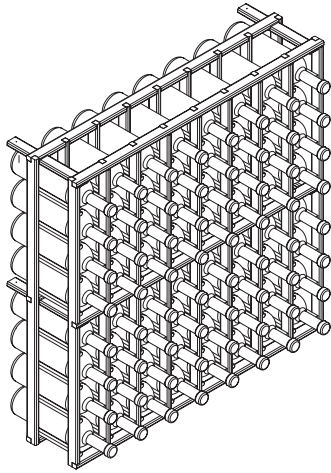

↕ 32"

↔ 32"

△ 9 1/2"

🍷 64
Bouteilles
Bottles

IB 32 48

Choisissez les casiers IB pour toutes vos bouteilles standards de 750 ml.
Choose IB racking to fit all of your standard 750ml bottles.

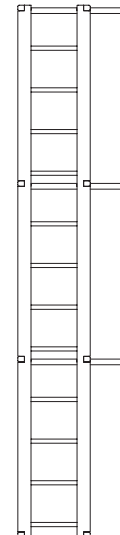
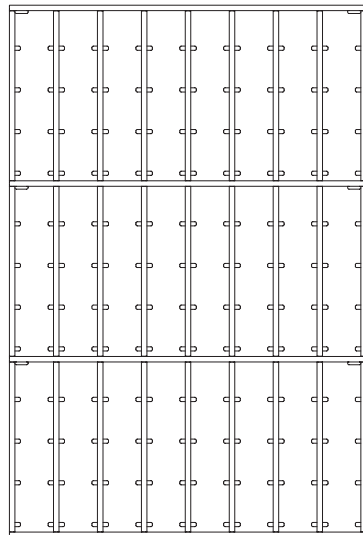
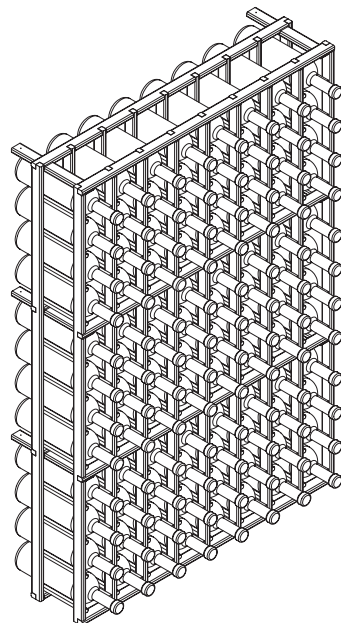

↕ 47 3/4"

↔ 32"





△ 9 1/2"

🍷 96
Bouteilles
Bottles

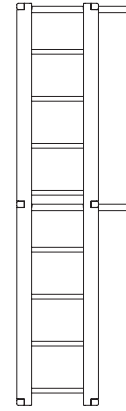
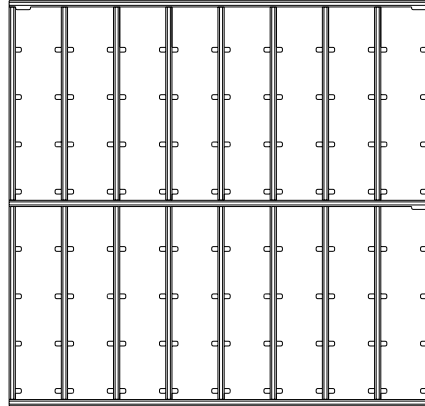
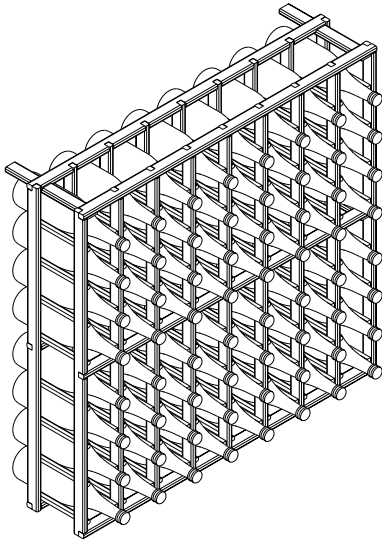
IB XL 32

Choisissez les casiers IB XL pour accommoder toutes vos bouteilles 750ml – incluant champagnes et format hors standard.
Chose IB XL racking to accommodate all you 750ml bottles – including champagne and non-standard.





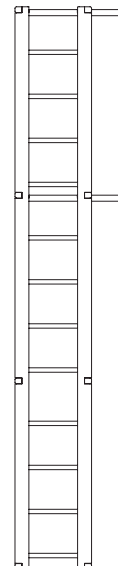
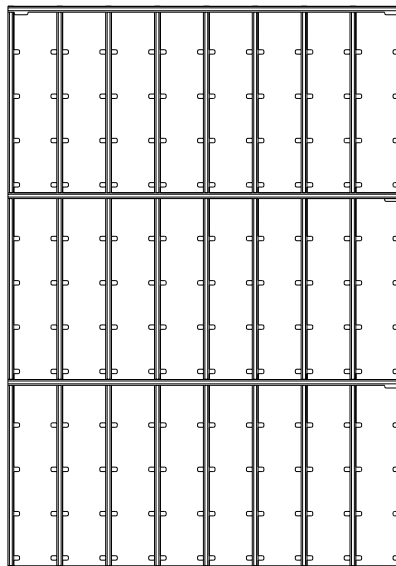
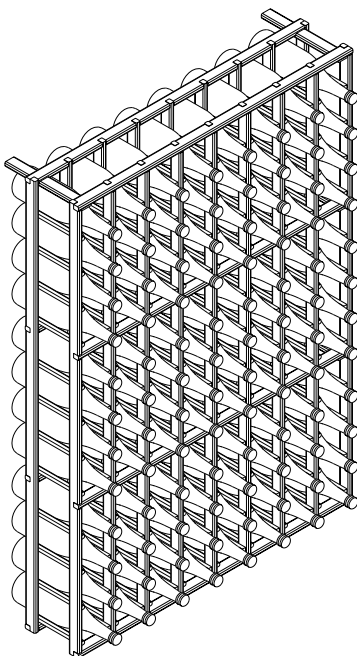

	32"
	33 1/2"
	9 1/2"
	64 Bouteilles Bottles

IB XL 48

Choisissez les casiers IB XL pour accommoder toutes vos bouteilles 750ml – incluant champagnes et format hors standard.
Chose IB XL racking to accommodate all you 750ml bottles – including champagne and non-standard.



	47 3/4"
	33 1/2"
	9 1/2"
	96 Bouteilles Bottles

IB ICE 32

Choisissez les casiers IB ICE pour l'entreposage de vos bouteilles de 375ml à 500ml dans votre cave à vin Distribution CAV inc.
Choose IB ICE racks to intergrate your 375ml-500ml bottles into your Distribution CAV inc. cellar.

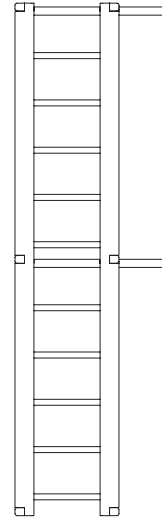
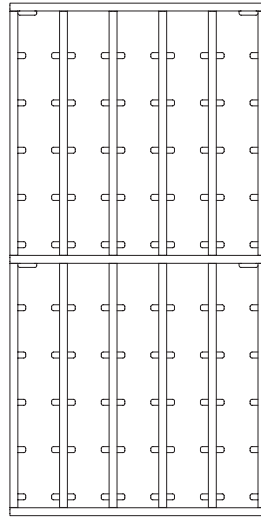
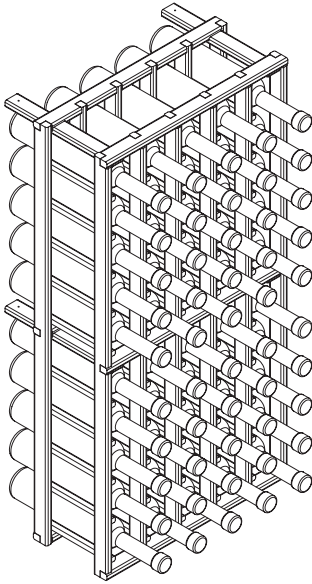

↕ 32"

↔ 16"

△ 9 1/2"

50
Bouteilles
Bottles
375 -500ml

IB ICE 48

Choisissez les casiers IB ICE pour l'entreposage de vos bouteilles de 375ml à 500ml dans votre cave à vin Distribution CAV inc.
Choose IB ICE racks to intergrate your 375ml-500ml bottles into your Distribution CAV inc. cellar.

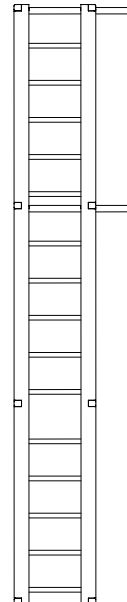
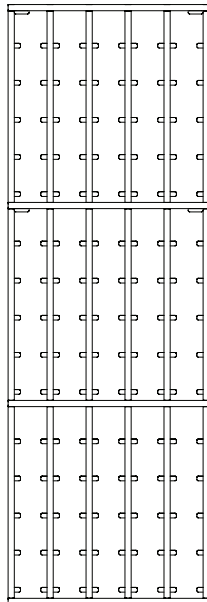
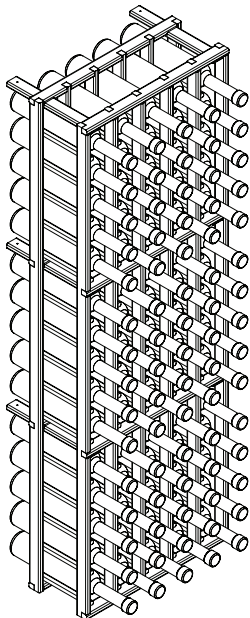

↕ 47 3/4"

↔ 16"

△ 9 1/2"

75
Bouteilles
Bottles
375 -500ml

CORNER 32

Le produit IB CORNER est idéal pour intégrer des casiers, combler les coins morts et maximiser la capacité globale de l'espace.
IB CORNER is the perfect component to transition racking from one wall to another without interrupting the flow of individual bottle storage. Perfect for filling dead corners and maximizing overall capacity.

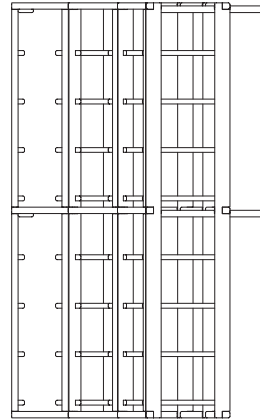
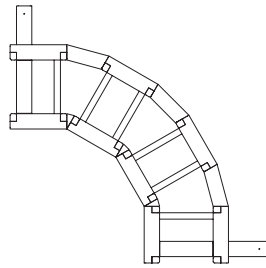
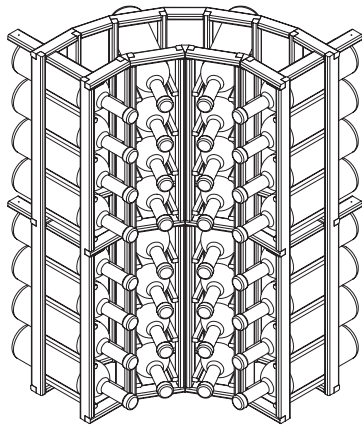



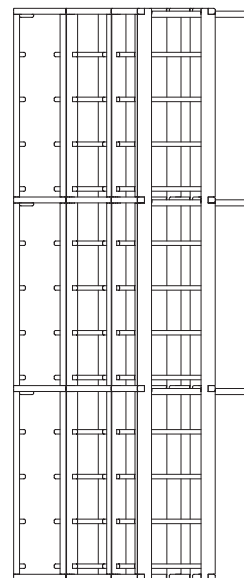
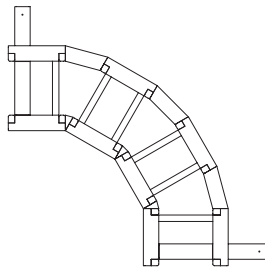
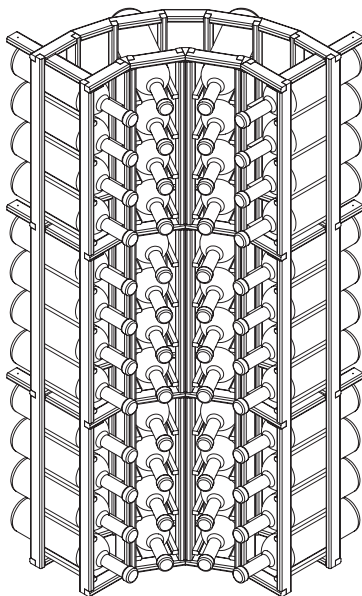

	32"
	19 13/16"
	19 13/16"
	32 Bouteilles Bottles

CORNER 48

Le produit IB CORNER est idéal pour intégrer des casiers, combler les coins morts et maximiser la capacité globale de l'espace.
IB CORNER is the perfect component to transition racking from one wall to another without interrupting the flow of individual bottle storage. Perfect for filling dead corners and maximizing overall capacity.



	47 3/4"
	19 13/16"
	19 13/16"
	48 Bouteilles Bottles

BURGUNDY 32

Les casiers BURGUNDY sont une excellente option pour entreposer les bouteilles de grand format et les bouteilles de formes uniques de 750 ml.
BURGUNDY racks are a great option to accommodate large format bottles and unique 750ml bottle shapes.

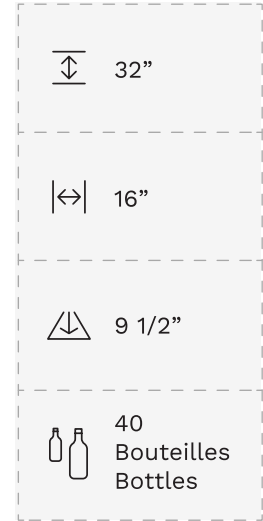
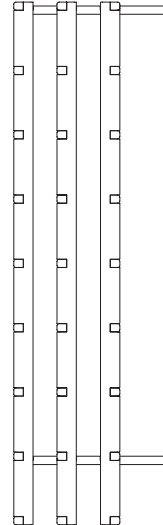
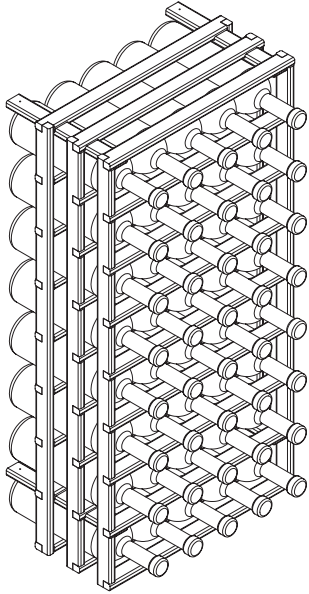

BURGUNDY 48

Les casiers BURGUNDY sont une excellente option pour entreposer les bouteilles de grand format et les bouteilles de formes uniques de 750 ml.
BURGUNDY racks are a great option to accommodate large format bottles and unique 750ml bottle shapes.

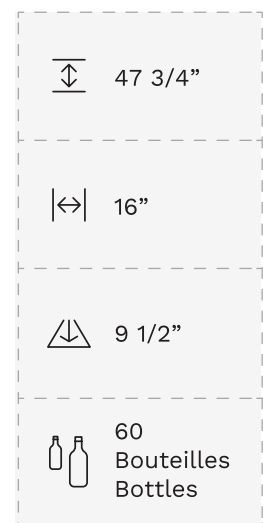
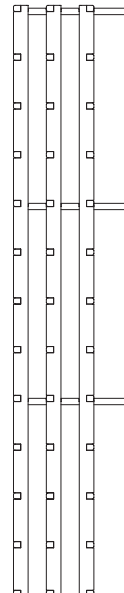
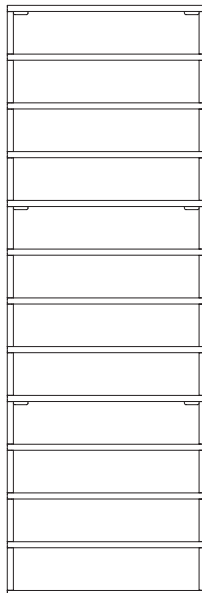
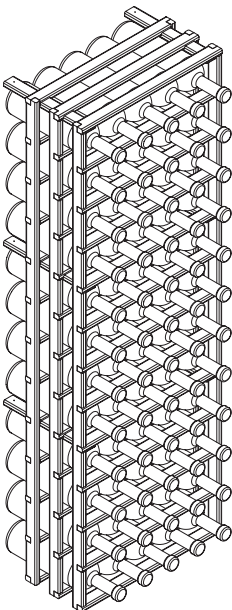

CHAMPAGNE 32

Utilisez les casiers CHAMPAGNE pour stocker des bouteilles de champagne et magnums.
Use CHAMPAGNE racks to store champagne and magnum sized bottles

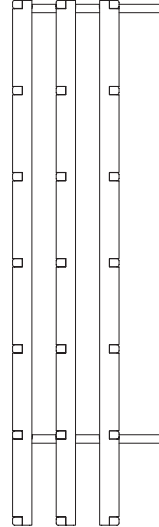
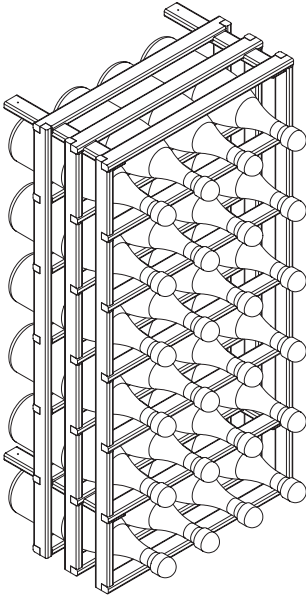

↕ 32"

↔ 16"

⚡ 9 1/2"

🍷 24
Bouteilles
Bottles

CHAMPAGNE 48

Utilisez les casiers CHAMPAGNE pour stocker des bouteilles de champagne et magnums.
Use CHAMPAGNE racks to store champagne and magnum sized bottles

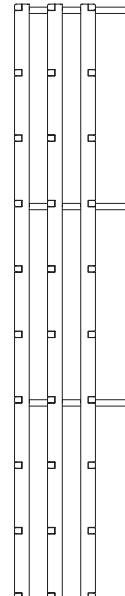
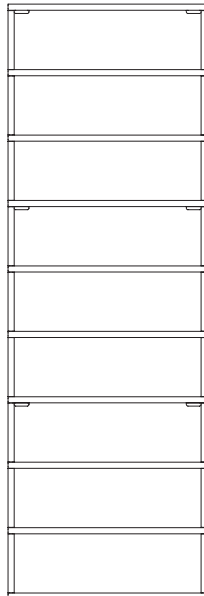
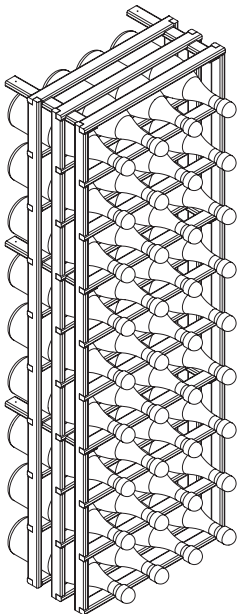

↕ 47 3/4"

↔ 16"





⚡ 9 1/2"

🍷 36
Bouteilles
Bottles

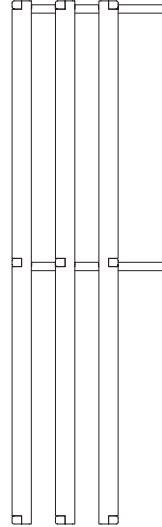
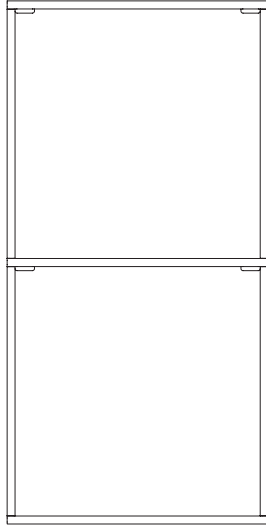
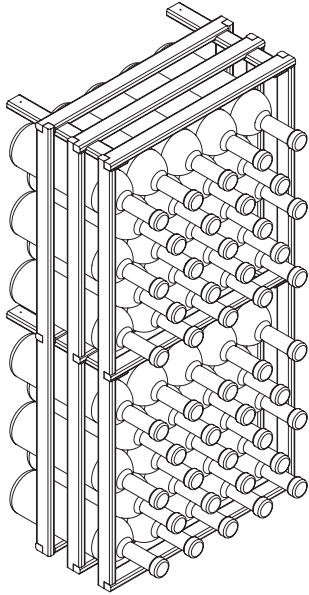
BIN 16 32

Choisissez le modèle BIN comme solution idéale pour l'entreposage en volume et des bouteilles en vrac ou surdimensionnées.
Ajoutez des séparateurs de casiers amovibles pour faciliter le tri et l'organisation. Voir page 12 pour plus de détails.
Choose BIN components as the ideal solution for bulk, oversized and loose bottle storage.
Add removable BIN dividers for ease of sorting and organization. See page 12 for more details.





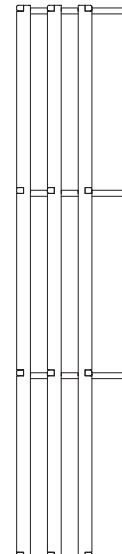
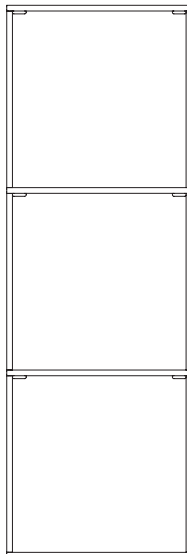
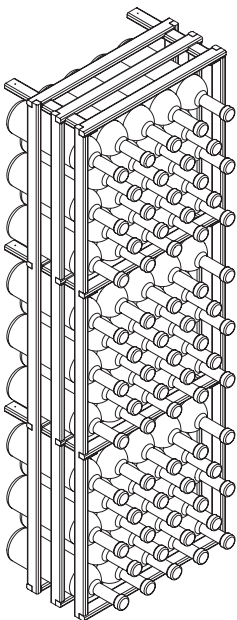

	32"
	16"
	9 1/2"
	46 Bouteilles Bottles

BIN 16 48

Choisissez le modèle BIN comme solution idéale pour l'entreposage de gros volumes et des bouteilles en vrac ou surdimensionnées.
Ajoutez des séparateurs de casiers amovibles pour faciliter le tri et l'organisation. Voir page 12 pour plus de détails.
Choose BIN components as the ideal solution for bulk, oversized and loose bottle storage.
Add removable BIN dividers for ease of sorting and organization. See page 12 for more details.







	47 3/4"
	16"
	9 1/2"
	69 Bouteilles Bottles

BIN 32 32

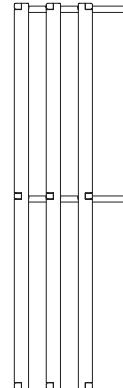
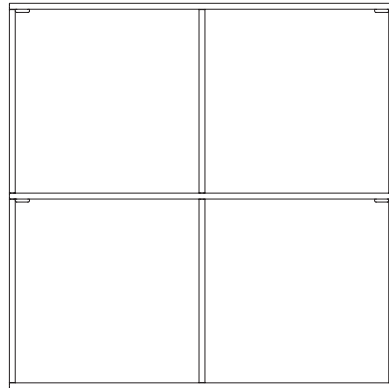
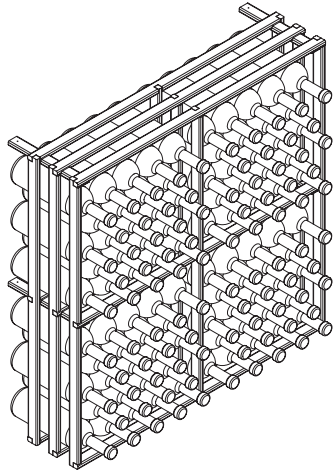
Choisissez le modèle BIN comme solution idéale pour l'entreposage de gros volumes et des bouteilles en vrac ou surdimensionnées. Ajoutez des séparateurs de casiers amovibles pour faciliter le tri et l'organisation. Voir page 12 pour plus de détails.

Choose BIN components as the ideal solution for bulk, oversized and loose bottle storage. Add removable BIN dividers for ease of sorting and organization. See page 12 for more details.







	32"
	32"
	9 1/2"
	92 Bouteilles Bottles

BIN 32 48

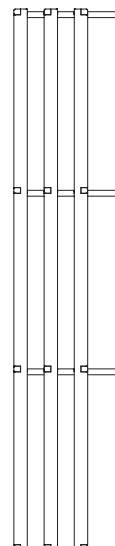
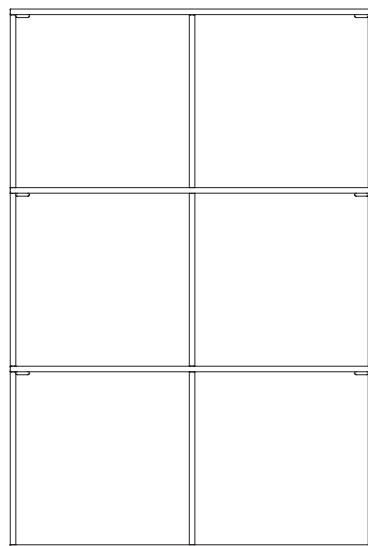
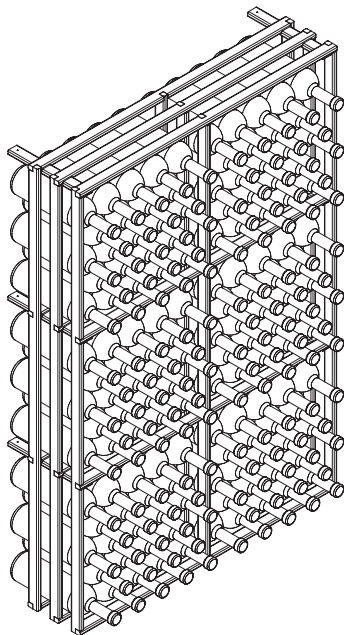
Choisissez le modèle BIN comme solution idéale pour l'entreposage de gros volumes et des bouteilles en vrac ou surdimensionnées. Ajoutez des séparateurs de casiers amovibles pour faciliter le tri et l'organisation. Voir page 12 pour plus de détails.

Choose BIN components as the ideal solution for bulk, oversized and loose bottle storage. Add removable BIN dividers for ease of sorting and organization. See page 12 for more details.







	47 3/4"
	32"
	9 1/2"
	138 Bouteilles Bottles

WOODCASE 32

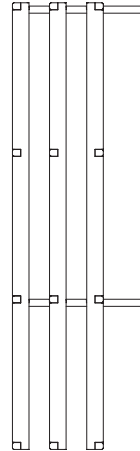
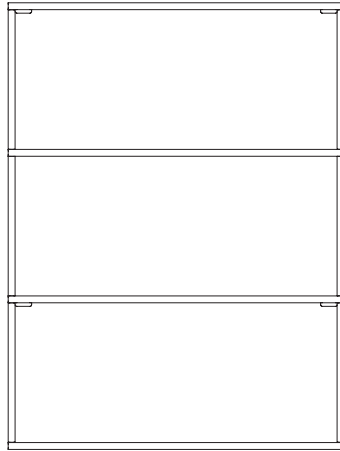
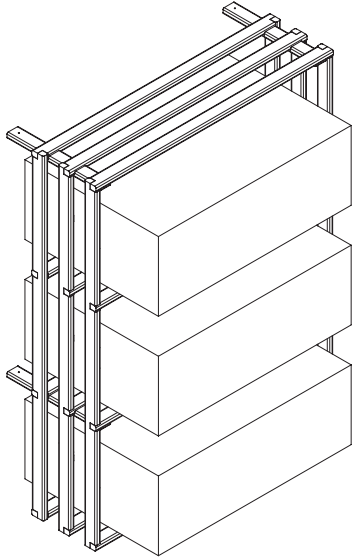
Les casiers en bois WOODCASE sont parfaits pour entreposer les caisses à long terme ainsi que pour laisser apparaître les étiquettes des vignobles prisés.

WOODCASE items are ideal for tucking away cases for long term storage as well as to show off prized vineyard logos.







	32"
	24"
	9 1/2"
	3 Caisse Cases

WOODCASE 48

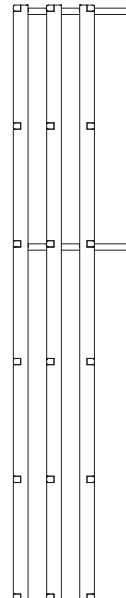
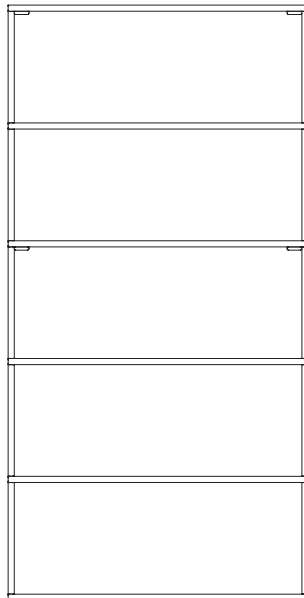
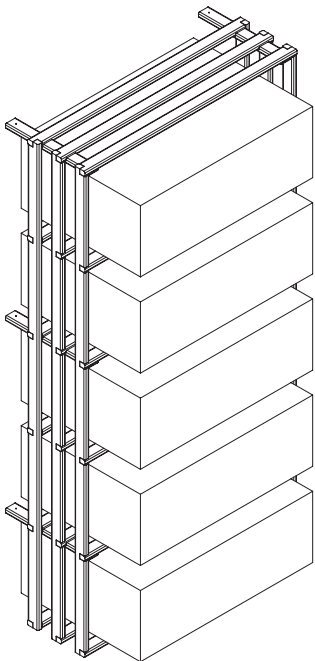
Les casiers en bois WOODCASE sont parfaits pour entreposer les caisses à long terme ainsi que pour laisser apparaître les étiquettes des vignobles prisés.

WOODCASE items are ideal for tucking away cases for long term storage as well as to show off prized vineyard logos.



	47 3/4"
	24"
	9 1/2"
	5 Caisse Cases

TASTING TABLE

Les tables de dégustation TASTING TABLE de Distribution CAV inc. offrent un lieu de rencontre idéal pour décanter et déguster vos vins tout en offrant un espace de stockage supplémentaire.

Tasting tables by Distribution CAV inc. create the ideal hghmeeting place in the cellar to share and decant wines while also providing additional storage.

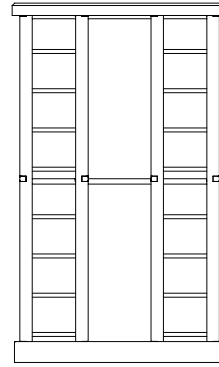
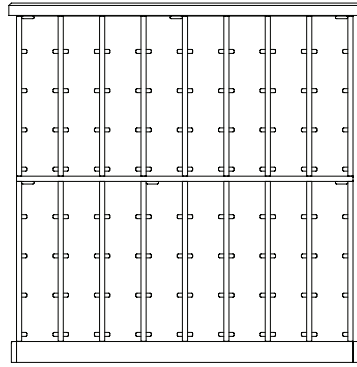
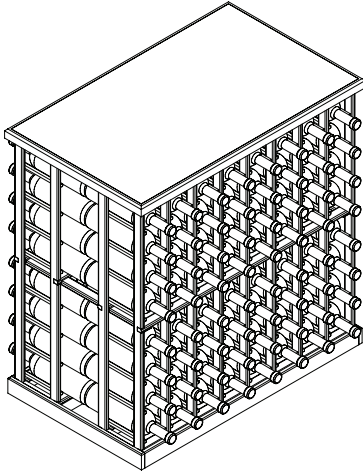

↕ 34 1/4"

↔ 33 1/2"

△ 20 1/2"

128
Bouteilles
Bottles

TABLE TOP

Un indispensable pour toute cave Distribution CAV inc.

Ajoutez une surface de travail et un espace pour décanter et servir vos vins avec un comptoir en acajou massif.

A must have for any Distribution CAV inc. cellar.

Create working space and an area to pour and decant wines with a solid mahogany counter.

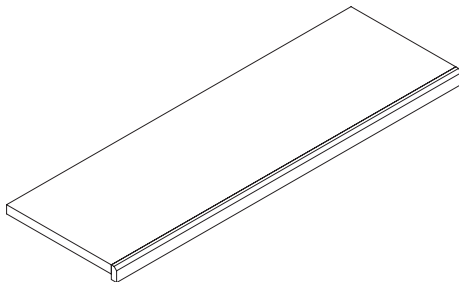

↕ 1 3/16"

↔ 32"

△ 10 3/16"

1/4 ROUND SHELF 32

Les étagères 1/4 ROUND sont la solution parfaite pour intégrer toute bouteilles hors format, ainsi que les spiritueux, verres et carafes.
The 1/4 ROUND is the perfect solution to bookend your wine cellar, as well as storing oversized bottles, spirits, glasses and decanters.

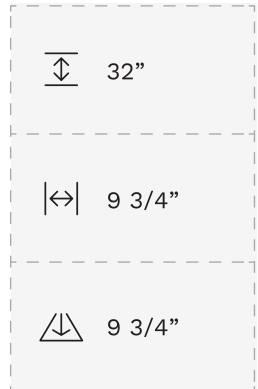
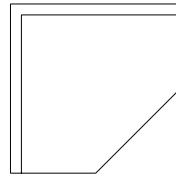
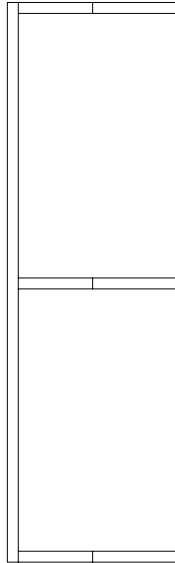
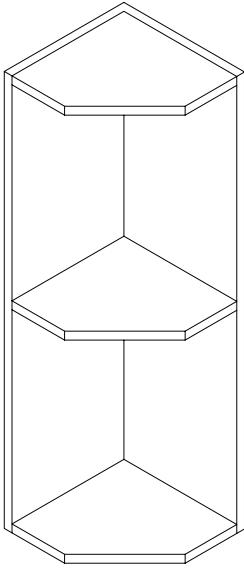

1/4 ROUND SHELF 48

Les étagères 1/4 ROUND sont la solution parfaite pour intégrer toute bouteilles hors format, ainsi que les spiritueux, verres et carafes.
The 1/4 ROUND is the perfect solution to bookend your wine cellar, as well as storing oversized bottles, spirits, glasses and decanters.

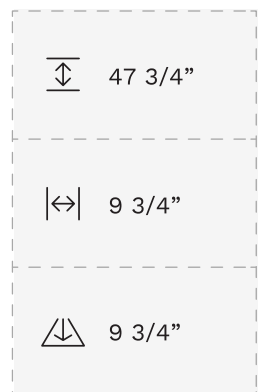
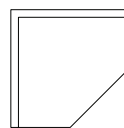
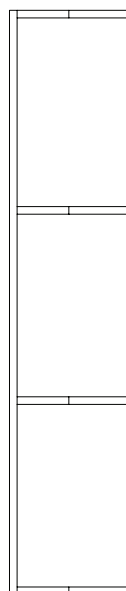
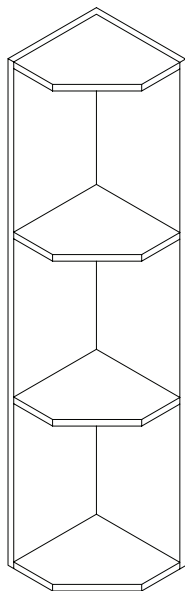

1/4 ROUND CROWN MOULD

La finition parfaite pour votre cave Distribution CAV inc. Habillez vos supports avec une moulure du couronnement.

The perfect finishing touch for your Distribution CAV inc. cellar. Trim racking and any exposed areas with a traditional style crown mould.

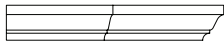
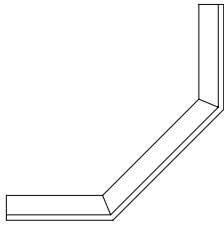

1/4 ROUND BASE MOULD

La finition parfaite pour votre cave Distribution CAV inc. Habillez la base de vos supports avec une plinthe.

The perfect finish for your Distribution CAV inc. cellar. Finish the bottoms of your wine racks with raised base mould.

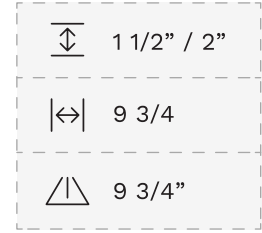
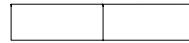
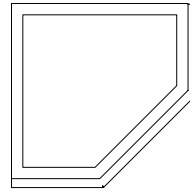
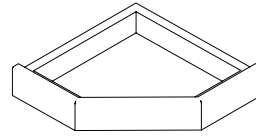

GLASS DISPLAY 32

Créez un espace pour disposer de façon fonctionnelle tous vos verres à pied.
Create a feature area within your wine racks as well as functional display for all of your stemware.

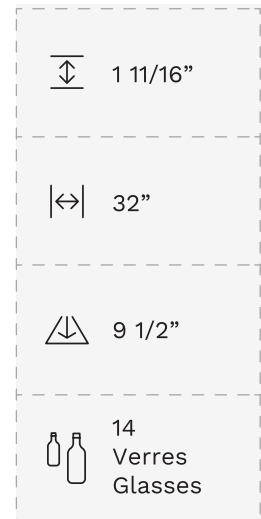
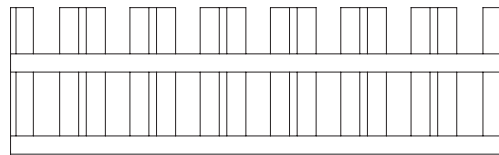
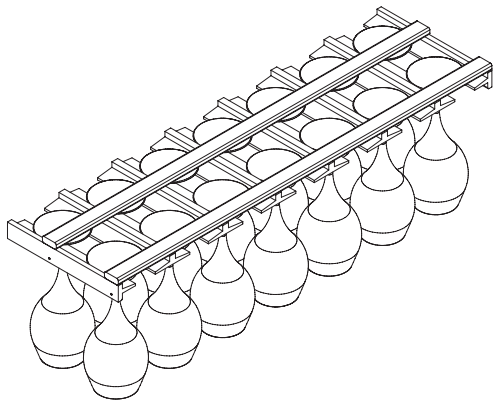

ANGLED DISPLAY

Installez un présentoir au-dessus des comptoirs ou des casiers pour mettre en valeur vos belles bouteilles et étiquettes.
Install a display on top of counters or racking to feature trophy bottles and special labels.

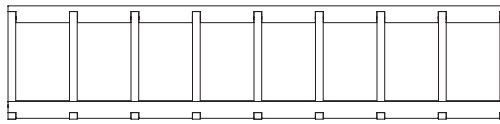
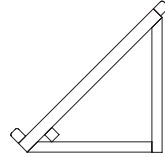
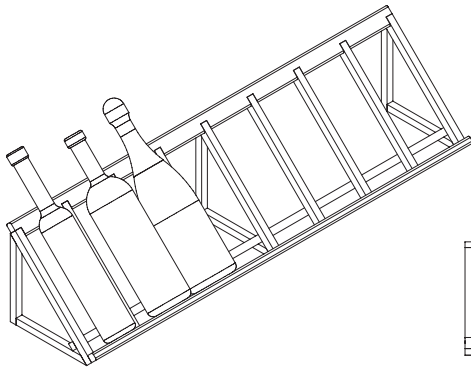

↕ 7 1/4"

↔ 32"

△ 7 1/4"

8 Bouteilles
Bottles

BIN DIVIDER

Une solution simple pour l'organisation de vos bouteilles. Utilisez un séparateur dans vos casiers pour ranger les bouteilles similaires entre elles.
A simple solution for collection organization. Use a divider in your BIN components to sort similar bottles.

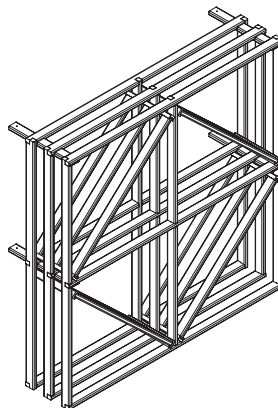
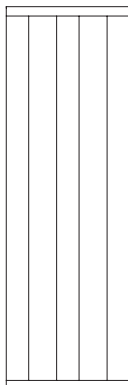
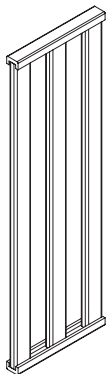

↕ 7/8"

↔ 20 1/4"

△ 6 1/2"

CROW MOULD

La touche finale parfaite pour votre cave à vin Distribution CAV inc. Habillez le haut de vos casiers avec une moulure du couronnement. Choisissez parmi les longueurs 16", 24", 32" ou 48".

The perfect finishing touch for your Distribution CAV inc. Trim racking and any exposed ceiling areas with a traditional style crown mould. Choose from 16", 24", 32" or 48" lengths.

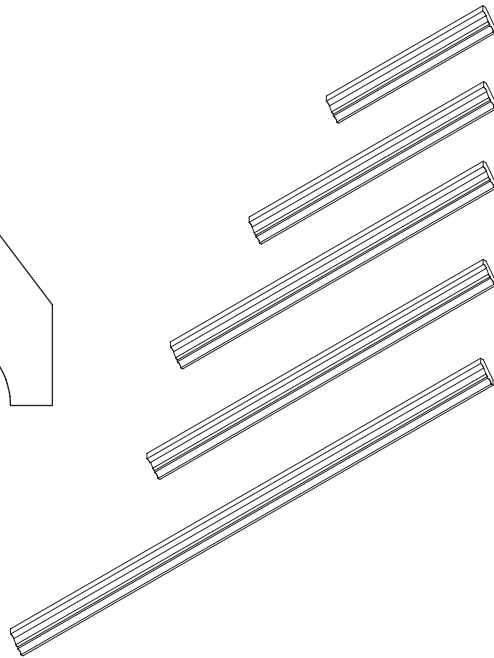
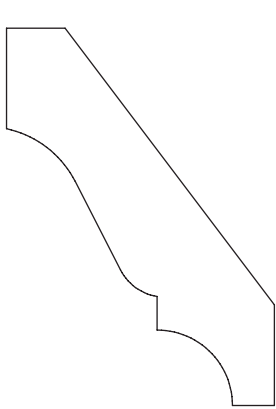

CROWN MOULD 16

CROWN MOULD 24

CROWN MOULD 32

CROWN MOULD IB XL

CROWN MOULD 48"

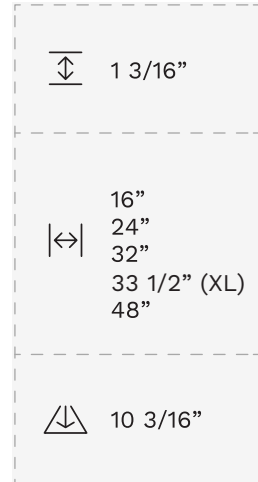

CROW MOULD CORNER

La finition parfaite pour votre cave Distribution CAV inc. Habillez vos supports avec une moulure du couronnement.

The perfect finishing touch for your Distribution CAV inc. cellar. Trim racking and any exposed areas with a traditional style crown mould.

MOULURE DU
COURONNEMENT
COIN INTÉRIEUR
CROWN MOULD
CORNER INSIDE

MOULURE DU
COURONNEMENT
COIN EXTÉRIEUR
CROWN MOULD
CORNER OUTSIDE

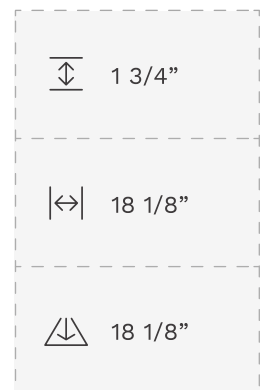
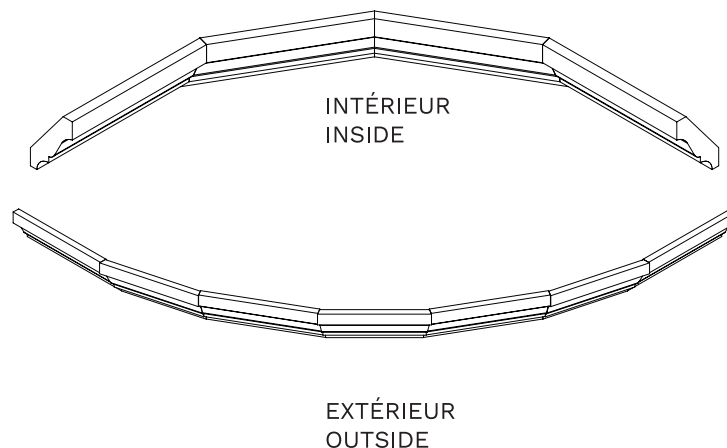
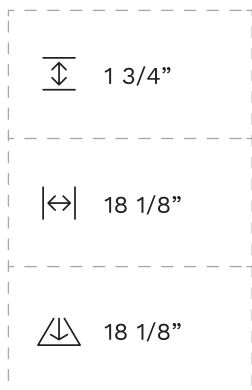

BASE MOULD

La finition parfaite pour votre cave Distribution CAV inc. Habillez la base de vos supports avec une plinthe.
The perfect finish for your Distribution CAV inc. cellar. Finish the bottoms of your wine racks with raised base mould.

BASE MOULD 2

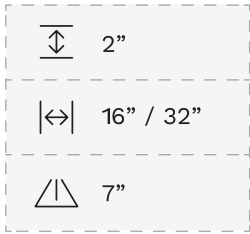

Pour les casiers ICE IB et IB, choisissez les tailles 16" ou 32".
For IB and IB ICE racks, choose from 16" or 32".

BASE MOULD 4'

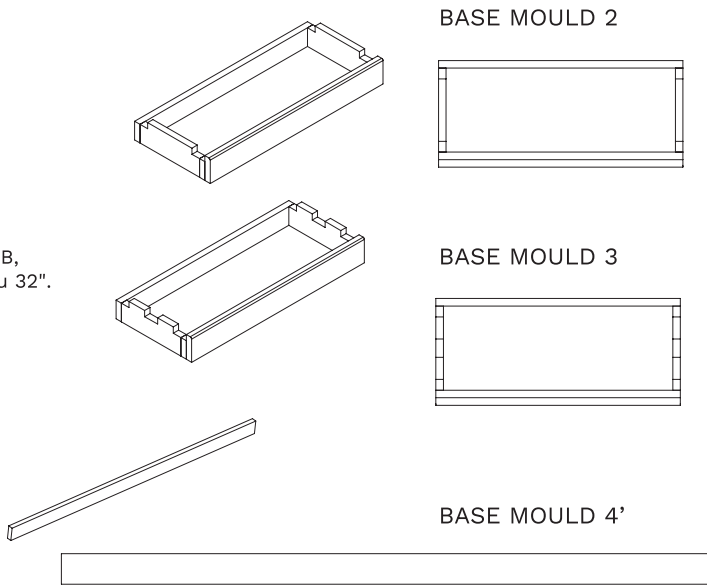
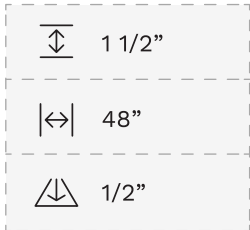

BASE MOULD IB XL

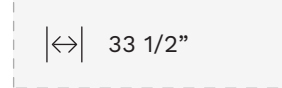

BASE MOULD 3

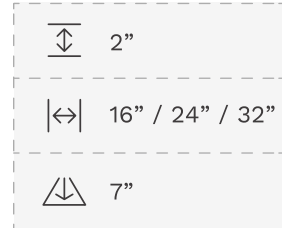

Pour les casiers CHAMPAGNE, BURGUNDY et BIN choisissez les tailles 16" ou 32".
Pour les casiers en bois WOODCASE, choisissez la taille 24".
For CHAMPAGNE, BURGUNDY and BIN racks. Choose from 16" or 32". WOODCASE is 24"

BASE MOULD CORNER

Habillez le bas de vos casiers avec une plinthe décorative surélevée.
Finish the bottoms of your wine racks with raised base mould.

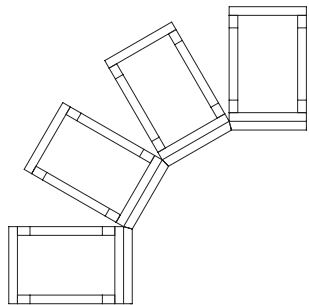

BASE MOULD CORNER INTÉRIEUR
BASE MOULD CORNER INSIDE

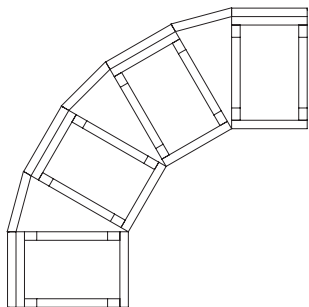
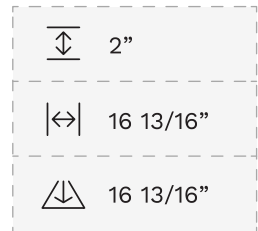
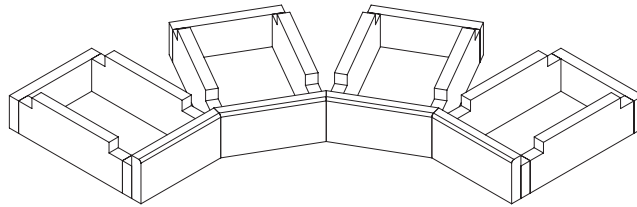

BASE MOULD CORNER EXTÉRIEUR
BASE MOULD CORNER OUTSIDE

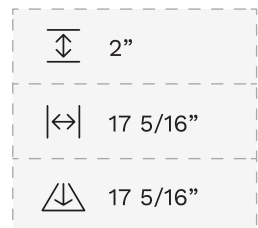
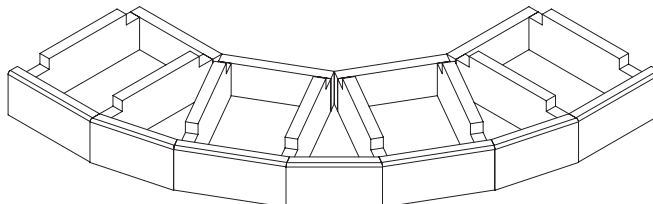

CLEATS

Agrandissez vos casiers avec l'option double-profondeur en ajoutant un taquet ou un installant un double taquet à vos casiers IB ou BIN.
Expand your racking with the option for double deep storage by ordering extra or double deep cleats for your IB or BIN racks.

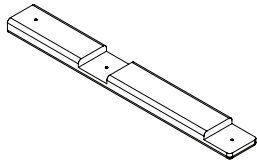

SINGLE DEEP CLEAT
IB RACKING
SINGLE DEEP CLEAT
CASIER IB

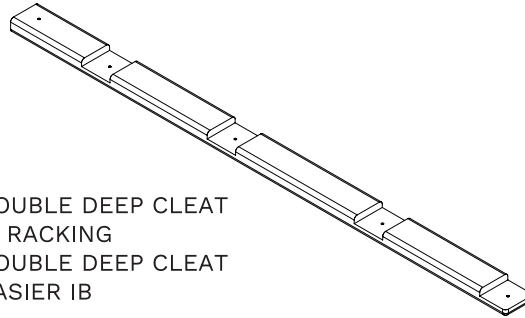

DOUBLE DEEP CLEAT
IB RACKING
DOUBLE DEEP CLEAT
CASIER IB

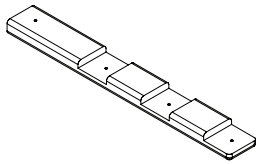

SINGLE DEEP CLEAT
BIN RACKING
SINGLE DEEP CLEAT
CASIER BIN

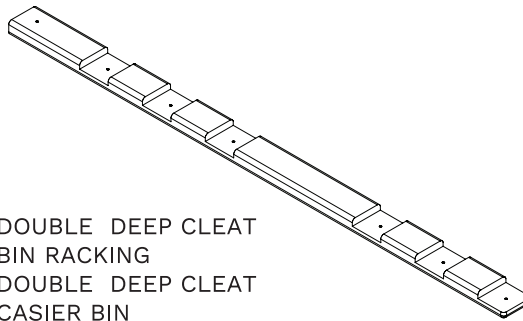

DOUBLE DEEP CLEAT
BIN RACKING
DOUBLE DEEP CLEAT
CASIER BIN

SINGLE DEEP CLEATS

↕ 1/2"

↔ 13/16"

⚠ 9 3/8"

DOUBLE DEEP CLEATS

↕ 1/2"

↔ 13/16"

⚠ 20 7/8"

FILLER

Utilisez les bandes de remplissage dans les coins ou entre les casiers pour uniformiser l'apparence.
Close gaps for a uniform appearance with filler strips in corners or between racks.

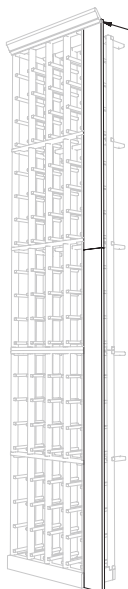

Couper la bande remplissage pour l'adapter à la hauteur des casiers.
Cut filler to fit racking height

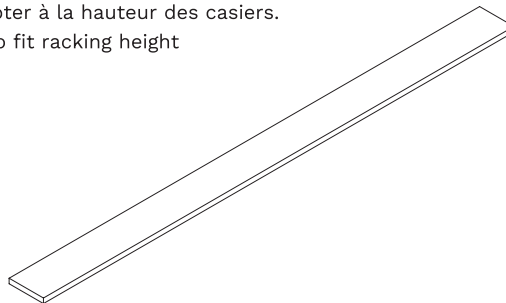

Profile
Profil

↕ 48" / 96"

↔ 3"

⚠ 1/2"

LISTE DE PRIX

PRICE LIST

ITEM	PRIX	ITEM	PRIX
IB 16 32	108.00 \$	1/4 ROUND SHELF 32	461.50 \$
IB 16 48	148.00 \$	1/4 ROUND SHELF 48	626.50 \$
IB 32 32	188.00 \$		
IB 32 48	251.00 \$	CROWN MOULD 16	8.50 \$
IB XL 32	200.00 \$	CROWN MOULD 24	11.00 \$
IB XL 48	272.00 \$	CROWN MOULD 32	17.00 \$
IB ICE 32	137.00 \$	CROWN MOULD XL	20.00 \$
IB ICE 48	159.50 \$	CROWN MOULD 48	21.50 \$
IB CORNER 32	205.00 \$	CROWN MOULD 96	46.00 \$
IB CORNER 48	251.00 \$	CROWN MOULD CORNER - INSIDE	21.50 \$
		CROWN MOULD CORNER - OUTSIDE	21.50 \$
BURGUNDY 32	131.50 \$	CROWN MOULD 1/4 SHELF	21.50 \$
BURGUNDY 48	159.50 \$		
		BASE MOULD IB 16	21.50 \$
CHAMPAGNE 32	119.50 \$	BASE MOULD IB 32	36.00 \$
CHAMPAGNE 48	148.00 \$	BASE MOULD IB XL	41.00 \$
		BASE MOULD BIN 16	22.50 \$
BIN 16 32	85.50 \$	BASE MOULD BIN 24	36.00 \$
BIN 16 48	97.00 \$	BASE MOULD BIN 32	42.50 \$
BIN 32 32	125.00 \$	BASE MOULD CORNER - INSIDE	42.50 \$
BIN 32 48	142.50 \$	BASE MOULD CORNER - OUTSIDE	42.50 \$
		BASE MOULD 1/4 SHELF	42.50 \$
WOODCASE 32	102.50 \$	BASE MOULD 48	18.50 \$
WOODCASE 48	148.00 \$	BASE MOULD 96"	41.00 \$
		DOUBLE DEEP CLEAT IB (X4)	47.00 \$
GLASS RACK 32	125.00 \$	DOUBLE DEEP CLEAT BIN (X4)	47.00 \$
ANGLE DISPLAY 32	159.50 \$	EXTRA CLEAT IB (X4)	11.50 \$
BIN DIVIDERS PKG 2	34.50 \$	EXTRA CLEAT BIN (X4)	11.50 \$
BIN DIVIDERS PKG 3	51.50 \$	FILLER MATERIAL (3" x 48")	18.50 \$
		FILLER MATERIAL (3" x 96")	41.00 \$
TASTING TABLE 32	586.50 \$		
TABLE TOP 32	108.00 \$		