

PANTHAIRE

Apex 3500

User Manual

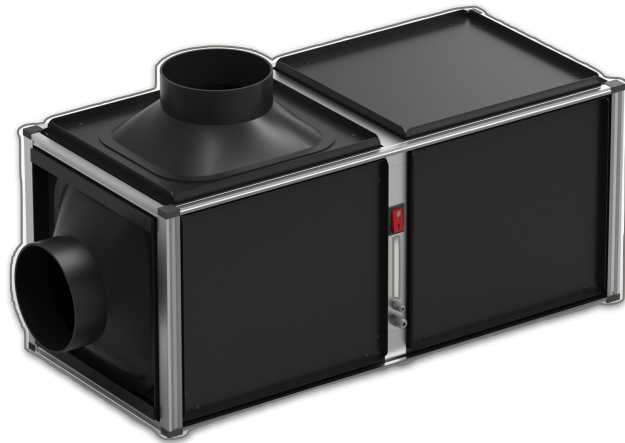

Product Overview

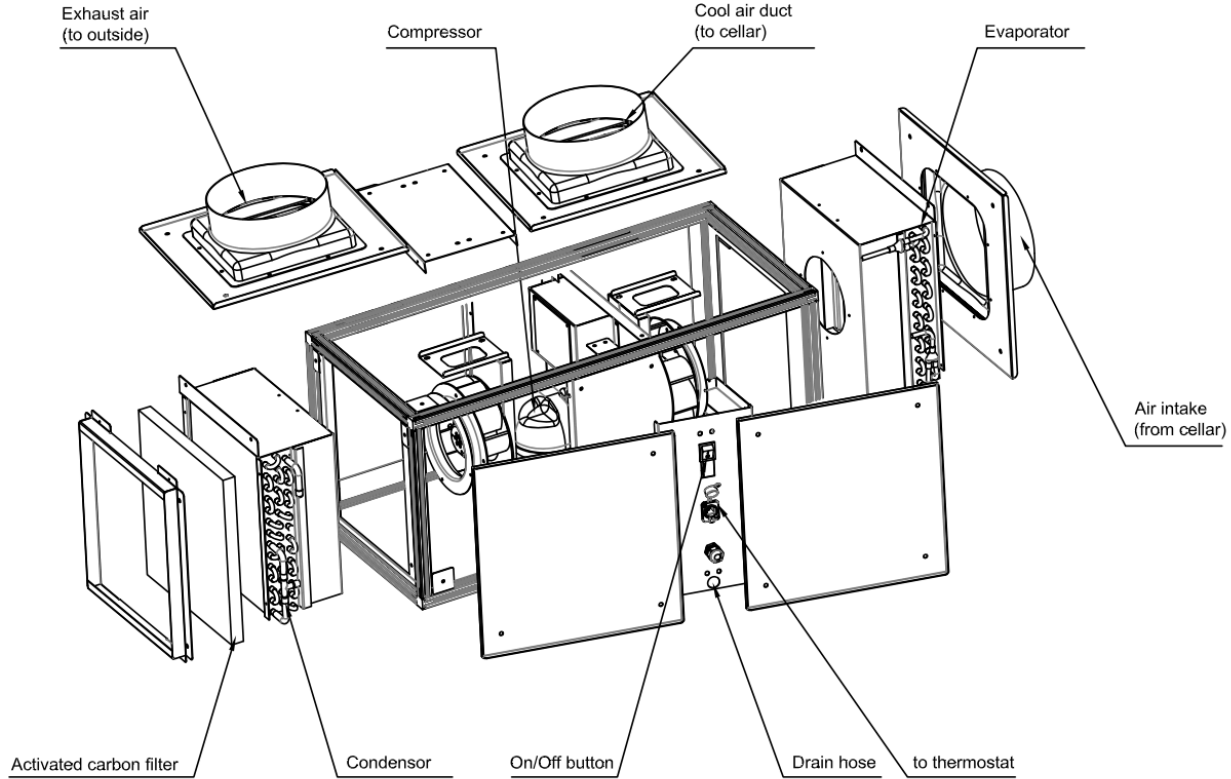

Ducting configuration



Use ductwork to connect the Panthaire unit to the supply and return outlets in your wine cellar. Use only insulated ductwork to minimize cooling losses, prevent condensation, and reduce noise. Use ductwork on the condenser section to redirect or absorb sound, bring in outside air to the unit inlet, and/or exhaust hot air.

Note: Do not exceed a total of 25 feet for each length of ductwork run and a combined total of 50 feet for both supply and return lengths.

Descriptive Diagram

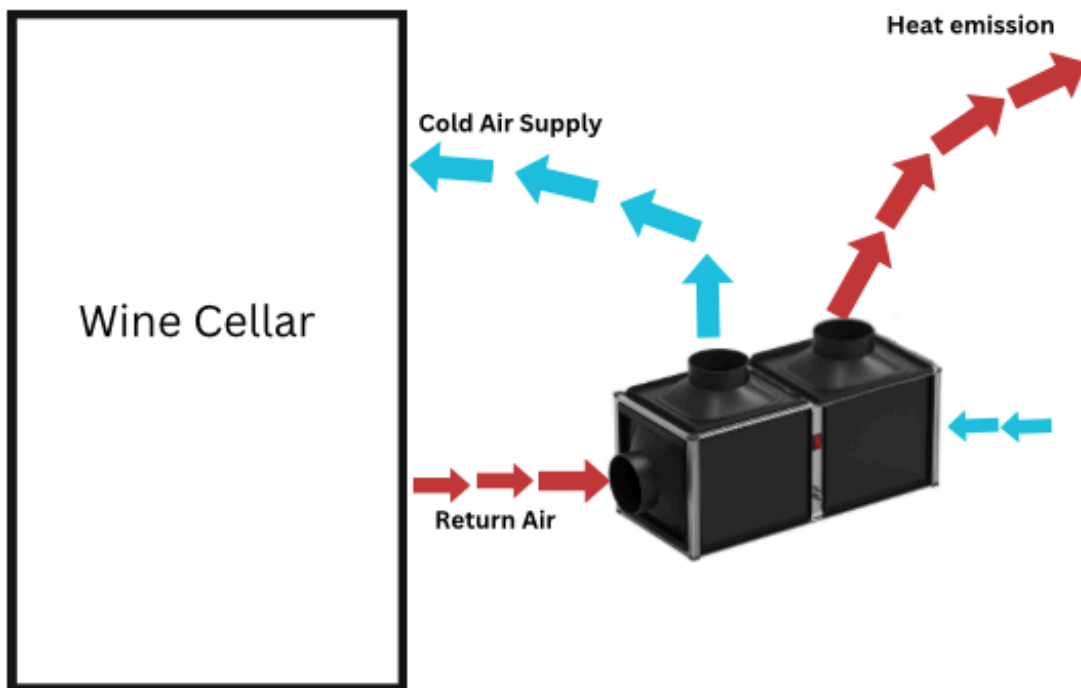

Unit Specifications



DIGITAL REMOTE CONTROL - THERMOSTAT	
Options	On/Off Temp+ Temp- F/C
Temperature	10 - 20 °C / 50 - 68 °F
Cable Length	10 Meters / 32 Feet
EVAPORATOR AND CONDENSER SECTION	
Fan Motor	75W
Airflow	245 CFM
Static Pressure	30 Pa
COMPRESSOR	
Power	0.33 HP / 3500 BTU
Refrigerant	R134A
ELECTRICITY	
Capacity	120V / 60Hz / 1Ph
Amp.	6.8A
Circuit	20A (Dedicated circuit is required)
FRAME	
Materials	Galvanized Aluminum
Finish	Black coating
DIMENSIONS	
Length x Height x Width	34.25" x 14.20" x 14.60" 870 x 360 x 370 mm
Weight	32kg / 71lbs
DRAIN	
Interior	3/8" (Clear plastic tube provided)
INSTALLATION	
Duct size Supply and Return	8"
Duct maximum length	25' Each duct

START-UP AND OPERATING INSTRUCTIONS

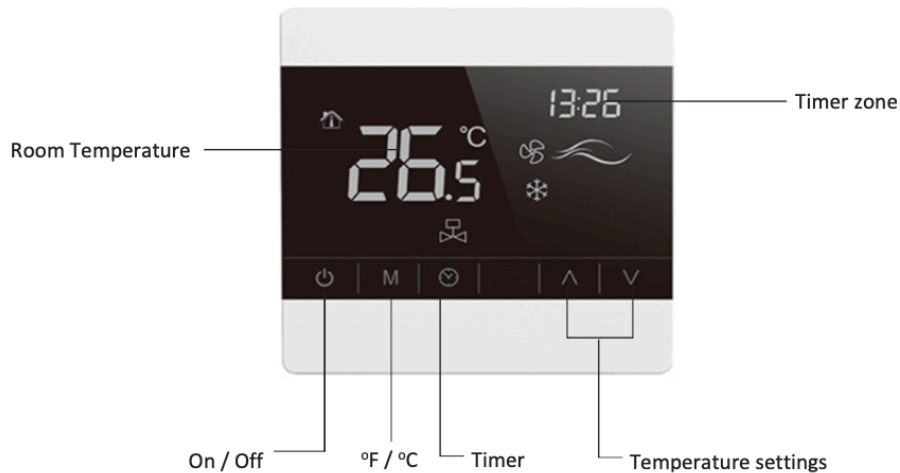







Power On / Off

After power, press the power button  to power on or off.



Temperature Settings

Press up  or down  to adjust the temperature, setting temperature range: 50~77 °F.

Clock Setting

Press  to set the current time, when the minute number flashes, press up  or down  to set the correct minutes, press  then hour number flashes, set the correct hours by pressing up  or down .

Timer Setting

Long press  after 5 seconds, it will show Timer OFF, Set the Timer ON (minutes & hours) by pressing up  or down .

Error codes & Trouble Shootings

Note: Please follow the steps below for the further information

SN	FAULT CODE	POSSIBLE CAUSES OF FAILURE
E6	Temperature Sensor Fault	Check whether the temperature sensor is broken, replace it.

CONDENSATION DRAIN LINE OVERVIEW

The condensation drain line tube is used to drain excess condensation from the unit to a proper discharge location. It is important that the drain line tube be properly connected in order to prevent leakage and other problems associated with excess condensation.

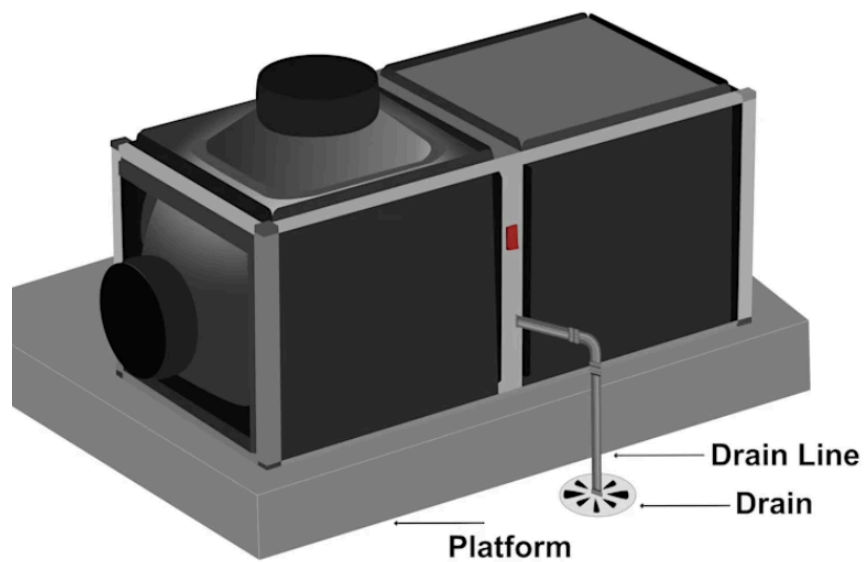

Installation



In the wine cellar: To ensure adequate air circulation, prepare two (2) openings for supply and return air. These openings should have dimensions of 6" x 12" and be strategically placed, one at the top (for supply) and one at the bottom (for return) of the cellar. It is essential to install two (2) finishing grilles, one for each opening, to ensure both aesthetics and safety.

Ductwork: Use eight (8") inch diameter ducts to connect the cellar to the mechanical room, ensuring that the distance between them does not exceed 25 feet.

Cellar insulation:

Wall Insulation: Use insulation with an R20 factor, complemented by a vapor barrier on the warm side of the insulation and a moisture-resistant gypsum interior lining.

Ceiling Insulation: Opt for insulation between R20 and R30 factors, also with a vapor barrier.

Floor Insulation (recommended): Insulate the floor to R20 with a vapor barrier being essential, especially if the cellar is not located in the basement. Be sure to avoid moisture-sensitive coverings and maintain a distance of 12 inches between the cellar and heated floors.

Doors and glass walls: To ensure effective thermal insulation, we recommend using thermal doors with a cold frame. If you opt for glass doors, make sure they have a minimum thickness of 12mm.

Mechanical room: In the mechanical room, please provide a drain that will be connected to the machine to remove excess water. The cooling unit should be installed on wall or floor supports.

Electricity: Ensure you have a dedicated 120V 15A power outlet for the Panthaire unit in the mechanical room for its electrical supply.

Cleaning and Maintenance Instructions



Filter Cleaning: Turn off the unit and unplug it from the power source. Gently remove the air filter from the unit. Use a handheld vacuum or gently brush the filter to remove dust and debris. If necessary, wash the filter with warm water and mild detergent. Ensure it is completely dry before reinstalling it.

Duct Cleaning: Regularly check the ducts for any accumulation of dust or dirt. Use a vacuum cleaner to gently vacuum the ducts, taking care not to damage internal components. If obstructions persist, consider hiring a professional for thorough cleaning.

Seal and Connection Inspection: Periodically check all duct seals and connections to ensure they are airtight. If leaks are detected, tighten connections or replace faulty seals.

Drain Check: Ensure that the machine's drain is clean and unobstructed. Check for any blockages or obstructions that could prevent water drainage.

General Examination: Inspect the unit overall for any signs of damage or malfunction. If you notice any issues, contact a qualified professional for repairs or additional maintenance.

Seasonal Maintenance: Schedule regular checks and maintenance of your refrigeration system according to manufacturer recommendations. Perform thorough cleaning before and after peak usage seasons to maintain optimal performance.

Safety: Always make sure to disconnect the unit from the power source before performing any cleaning or maintenance. Follow all manufacturer instructions carefully to avoid injury or damage to the unit.

Warnings



Electricity: Before beginning any cleaning or maintenance operation, always ensure to disconnect the unit from the power source to avoid the risk of electric shock.

Chemicals: Avoid using aggressive or corrosive chemicals when cleaning the unit, as they could damage internal components and compromise the proper functioning of the appliance.

Handling: Handle unit parts with care to avoid injuries. Some parts may be sharp or have sharp edges.

Professionalism: If you are unsure about correctly performing maintenance or cleaning tasks, it is recommended to seek assistance from a qualified professional to avoid the risk of unit damage or personal injury.

Safety: Ensure that the unit is completely cooled down before starting any cleaning or maintenance operation to avoid burns. Never block the unit's air ducts, as this can lead to overheating and damage to the appliance.

Regular Inspection: Do not neglect the importance of regularly inspecting the unit to detect any signs of damage or malfunction. Ignoring warnings can lead to more serious issues in the future.

Professional Contact: If you encounter any issues regarding the maintenance or operation of the unit, immediately contact a qualified professional for assistance. Do not attempt repairs if you are not a qualified professional in this field.

By carefully following these warnings and performing regular maintenance on your refrigeration unit, you can ensure safe and efficient operation of the appliance while prolonging its useful life.

Warranty



Two (2) years limited warranty.

The warranty covers manufacturing and material defects for a period of two years from the date of purchase. During this period, any Panthaire product exhibiting defects will be repaired or replaced free of charge by the manufacturer.

Important: This limited warranty is valid and applicable only in Canada and the United States.

Warranty Conditions:

- The warranty is valid only for the original purchaser and is non-transferable.
- To avail the warranty, the purchaser must retain the original proof of purchase.
- The warranty does not cover damages resulting from misuse, improper installation, unauthorized modifications, or negligence.
- Any warranty claim must be submitted to the manufacturer within specified timeframes and in accordance with the specified procedures.
- The manufacturer reserves the right to decide whether repairs will be conducted on-site or if the product must be returned to the factory for repair or replacement.
- The warranty covers labor costs associated with installation, disassembly, or repair of the product.

For any warranty service requests, please contact our customer service providing the details of your product along with the proof of purchase.

Email address: info@Panthaire.com

FAQ and Troubleshooting



- **Q:** The unit does not turn on.
- **A:** Check that the unit is properly plugged into a functional power source. If it is plugged in correctly and still does not turn on, contact our customer service for assistance.
- **Q:** The unit is not cooling effectively.
- **A:** Ensure that the filter is clean and the ducts are not obstructed. Also, check that the set temperature is lower than the ambient temperature. If the issue persists, contact our customer service for further diagnosis.
- **Q:** The unit is making excessive noise.
- **A:** Check for any obstructions around the unit that may be causing vibrations or unwanted noises. Also, ensure that the unit is installed on a flat and stable surface. If the noise continues, contact our customer service for assessment.
- **Q:** The wine cellar is not properly insulated with an R20 value.
- **A:** Ensure that the insulation of the wine cellar complies with the specifications recommended by the manufacturer of the Panthaire unit. Insufficient insulation can result in excessive cooling losses and system inefficiency. Add additional insulation if necessary and check for joints and areas where air leaks may occur.
- **Q:** Thermostat delay of 3 minutes.
- **A:** A thermostat delay can be due to various reasons, including incorrect settings or malfunction of the thermostat itself. First, check the thermostat settings to ensure they are correct. If the problem persists, consider replacing the thermostat or contacting a qualified professional for further diagnosis and repair.

If you encounter any other issues or have additional questions, feel free to contact our customer service. We are here to assist you in resolving any problems you may encounter with your Panthaire unit.

To Reach Us



Customer Service and Technical Support:

Email: info@panthaire.com

Address:

3732 Workman Street, Montreal, QC, H4C 1N8

Visit our website for more information and resources:

www.panthaire.com

Official Distributors:

Our products are available exclusively through our network of official distributors. To find a distributor near you, please visit our website or contact us directly.