

# Evolution Wine Wall 30 1C Extension

Spec Sheet for WW-EX303-1C (18-bottle extension, additional purchase required)

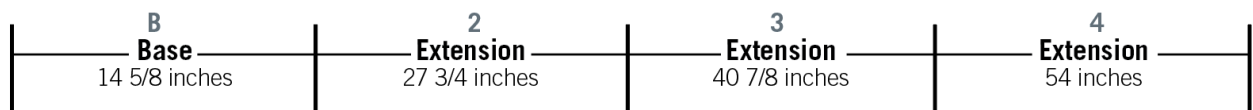
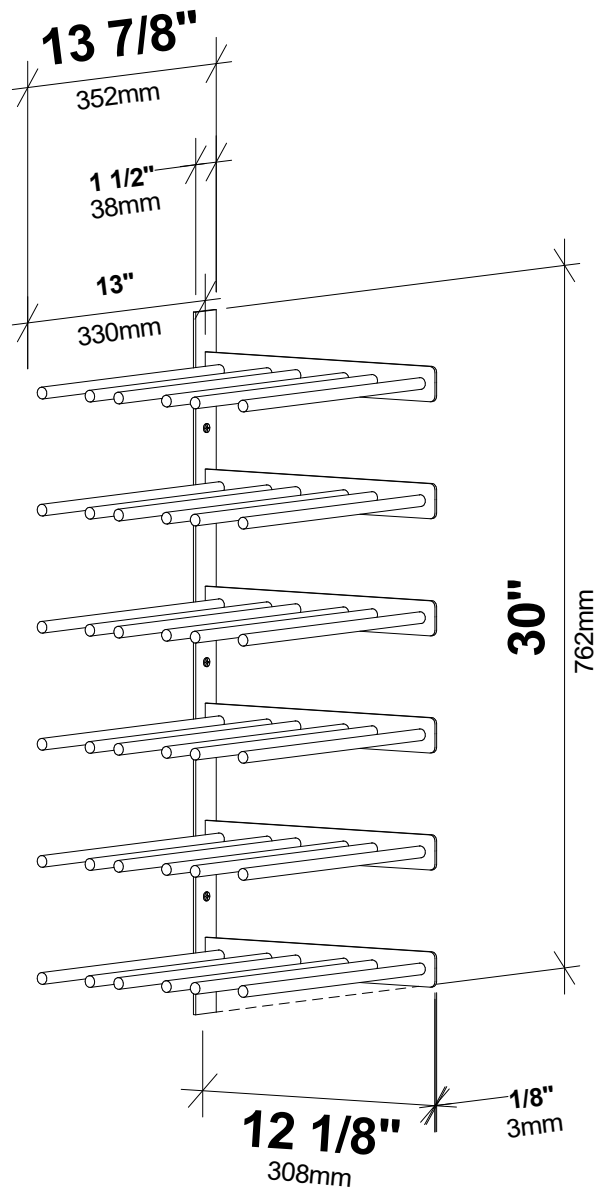

**VINTAGEVIEW®**  
MOVING WINE STORAGE FORWARD

4690 Joliet St., Denver, CO 80239 | phone: 866.650.1500 | fax: 866.650.1501 | [VintageView.com](http://VintageView.com)

For product warranty information, please visit [vintageview.com/warranty](http://vintageview.com/warranty)