

Evolution Wine Wall 30"

Spec Sheet for (WW-301-1C) 6-bottle wine rack.

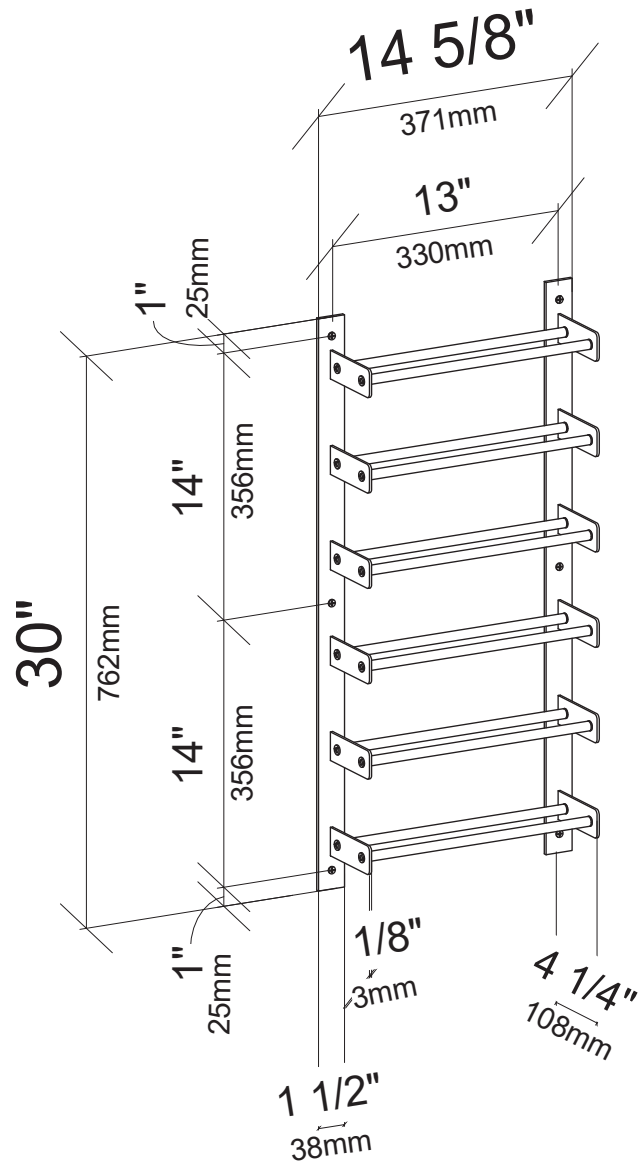

VINTAGEVIEW[®]
MOVING WINE STORAGE FORWARD

4690 Joliet St, Denver, CO 80239 | phone: 866.650.1500 | fax: 866.650.1501 | VintageView.com

For product warranty information, please visit vintageview.com/warranty