

Evolution Wine Wall 5 2C Extension

Spec Sheet for WW-EX051-2C (2-bottle extension, additional purchase required)

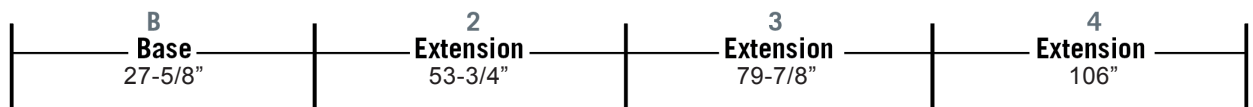
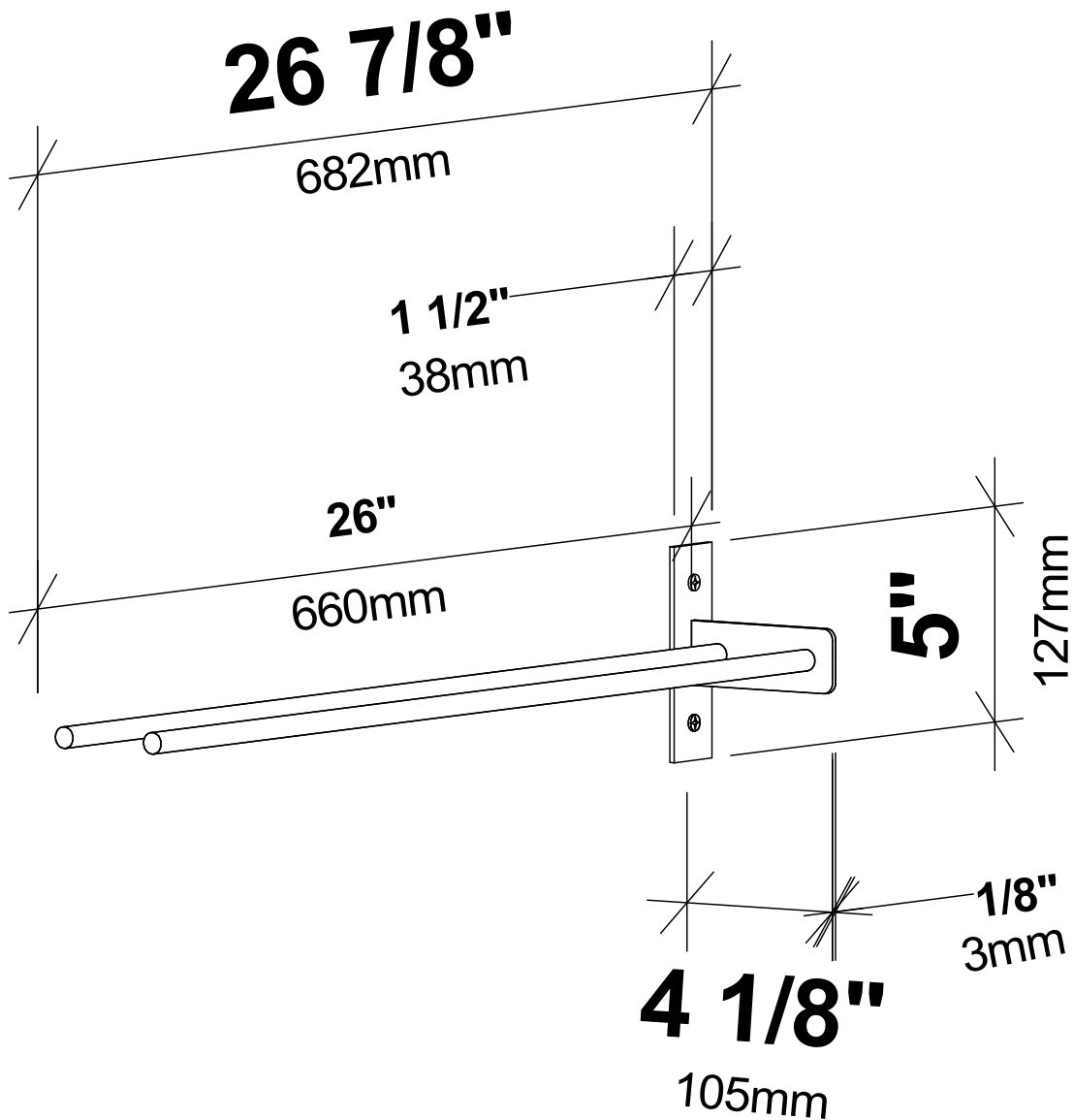

VINTAGEVIEW®
MOVING WINE STORAGE FORWARD

4690 Joliet St., Denver, CO 80239 | phone: 866.650.1500 | fax: 866.650.1501 | VintageView.com

For product warranty information, please visit vintageview.com/warranty